

Dual-Chemistry Battery Pack

Centre for Mechatronics and Hybrid Technology
Electrical and Computer Engineering McMaster University
Christina Riczu

EECOMOBILITY (ORF) &
HEVPD&D CREATE

OBJECTIVES

Range

To penetrate the electric vehicle market, EECOMOBILITY seeks to create a long-range electric vehicle that can travel 600 km on a single charge. This will allow the user to drive from Hamilton to Ottawa with range to spare.

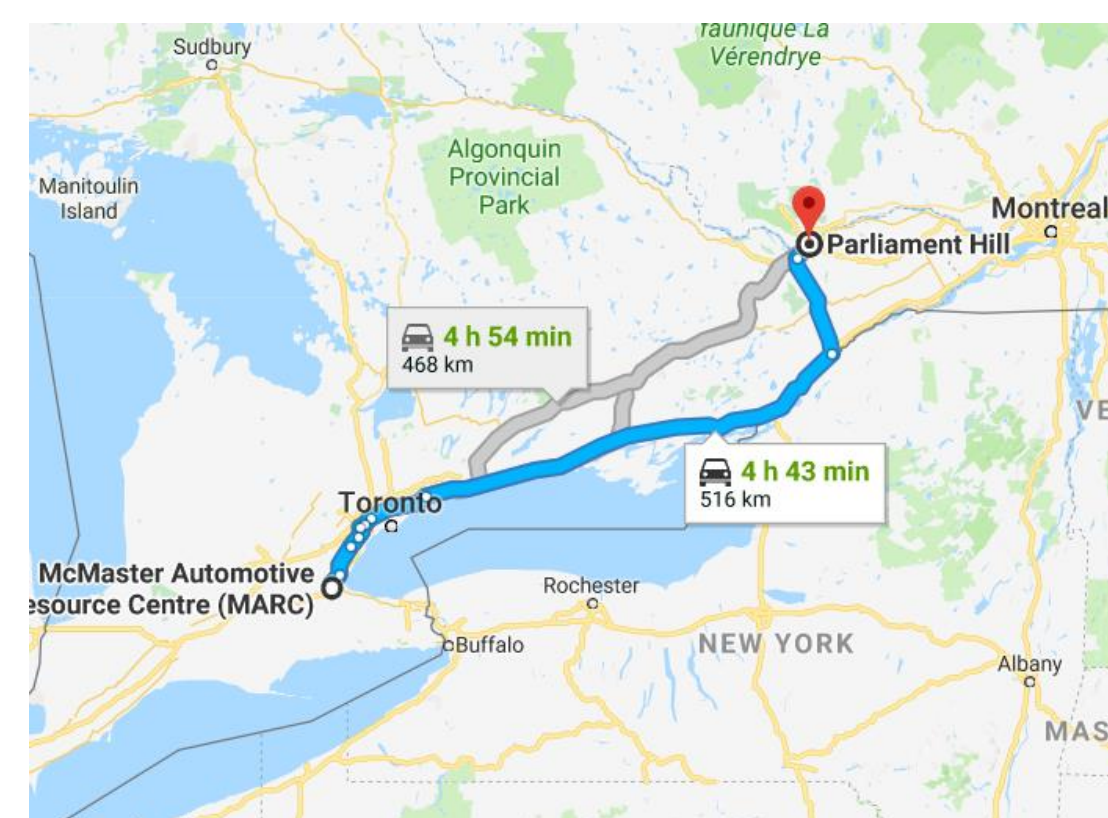

Efficiency

A state-of-the-art powertrain will allow the vehicle to use less energy per kilometer than electric vehicles on the market today.

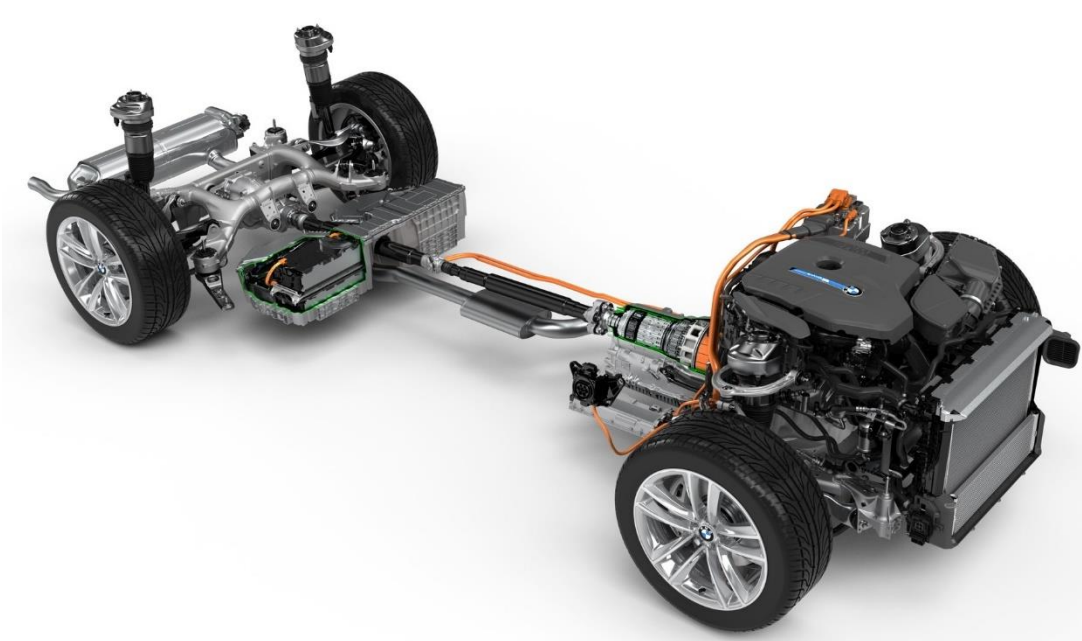

NOVEL BATTERY PACK

The battery pack is made up of many individual cells. These cells are packaged into modules, which in turn are stacked to create an entire battery pack. This modular form allows battery management systems to monitor and control the pack in a precise manner. Lithium-ion is the preferred chemistry for automotive manufacturers.



Adding Silicon

Lithium-ion cells typically use graphite as an anode material. Silicon can be used to improve the energy density of the cell. However, the volume expansion of the anode when lithiated restricts the practical improvement to 16%.

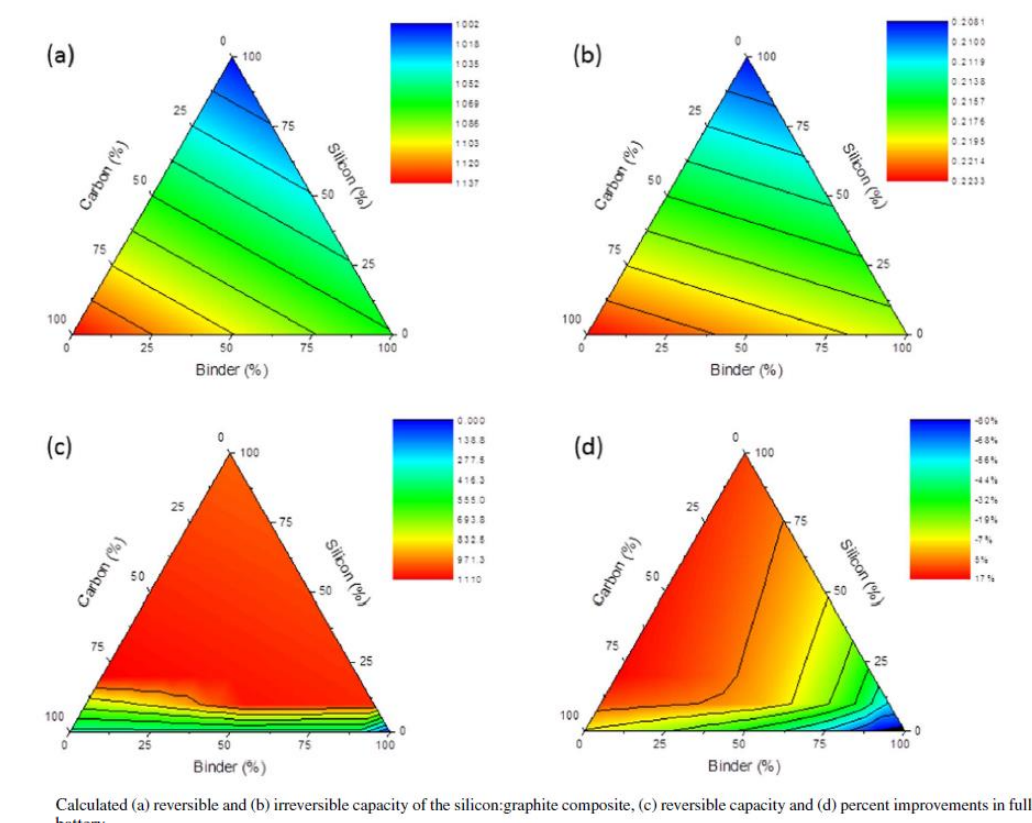

C.-H. Yim, S. Niketic, N. Salem, O. Naboka and Y. Abu-Lebdeh, "Towards Improving the Practical Energy Density of Li-ion Batteries: Optimization and Evaluation of Silicon-Graphite Composites in Full Cells," Journal of the Electrochemical Society, vol. 164, no. 1, pp. A6294-A6302, 2017.

VEHICLE MODELING

Goals

Optimal battery pack sizing for the dual-chemistry model is explored. The study quantified the effect of varying lithium-silicon pack sizing on the mass, cost, and energy use of the hybrid energy storage system.

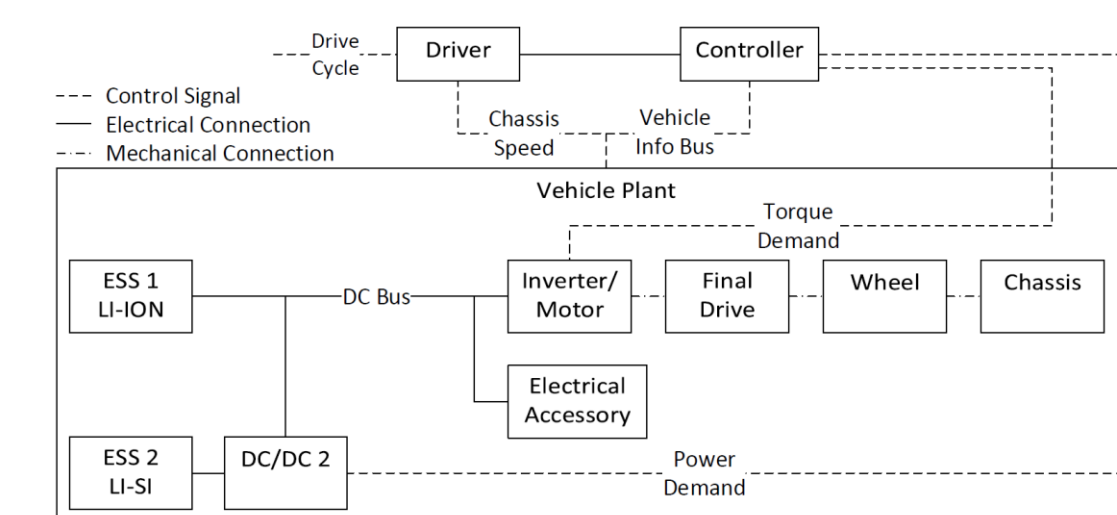

Topology 1

Architecture

Two vehicle architectures were investigated. The first topology has a lithium-ion pack directly connected to the motor and inverter, while the second is connected through a DC/DC converter.

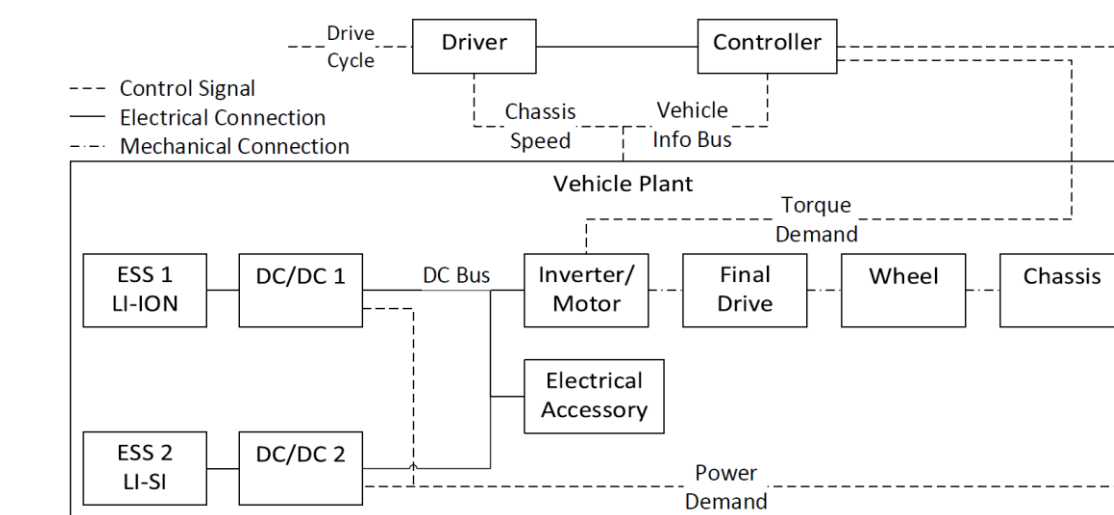

Topology 2

MODEL VALIDATION

The 2013 Ford CMAX Energi chassis will be the host of the novel powertrain. To validate the model, dynamometer data for this vehicle was used to produce the results below.

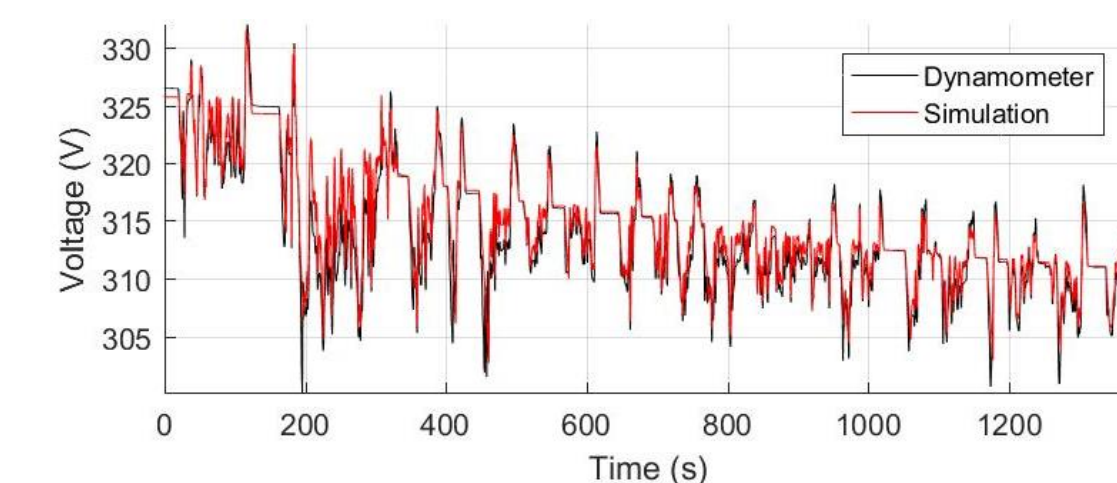
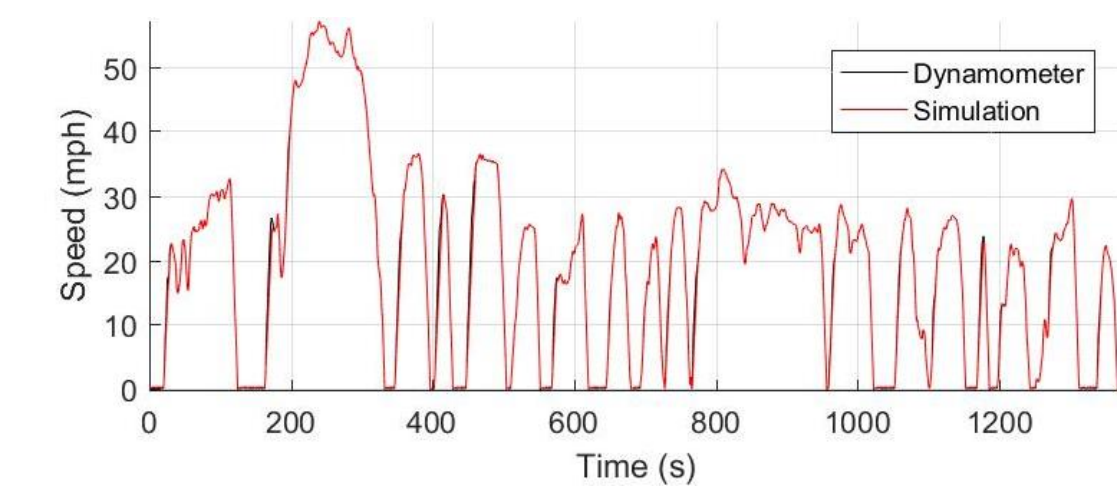

These results show that the model can be confidently used to predict vehicle behavior. The dual-chemistry battery pack can be added to measure performance.

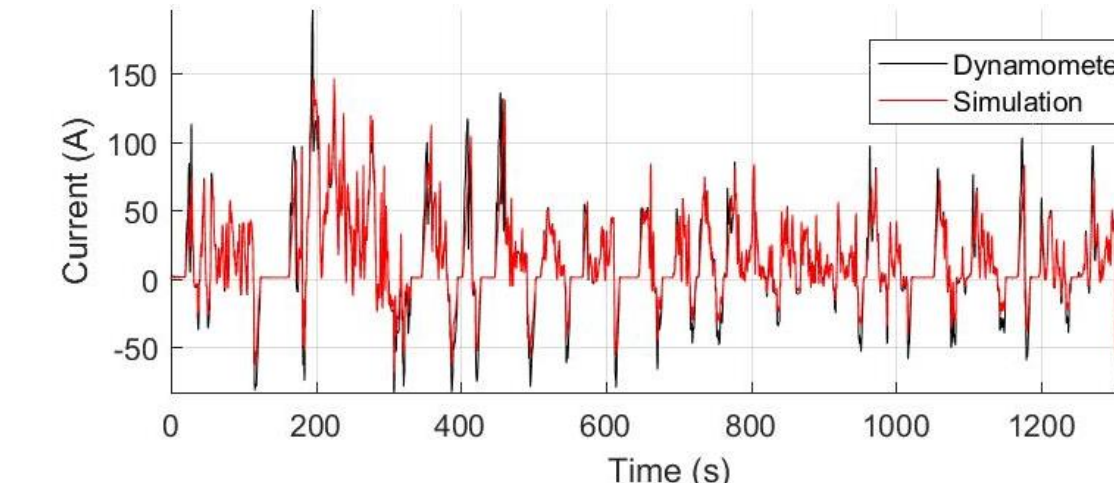
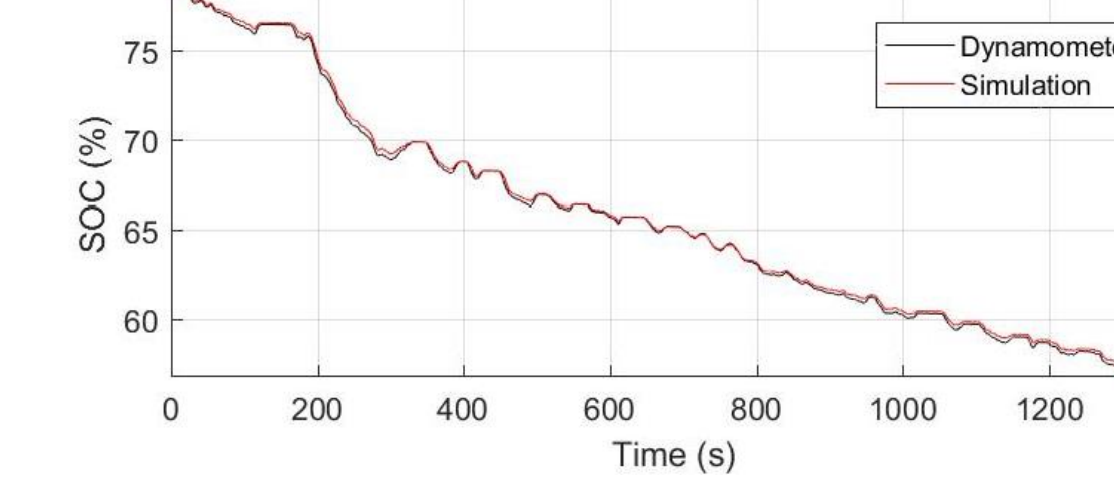

DUAL-CHEMISTRY MODEL

Sizing

The sizing of the lithium-silicon pack is varied in the study. The model scales the battery and DC/DC parameters based on the number of cells in series and parallel.

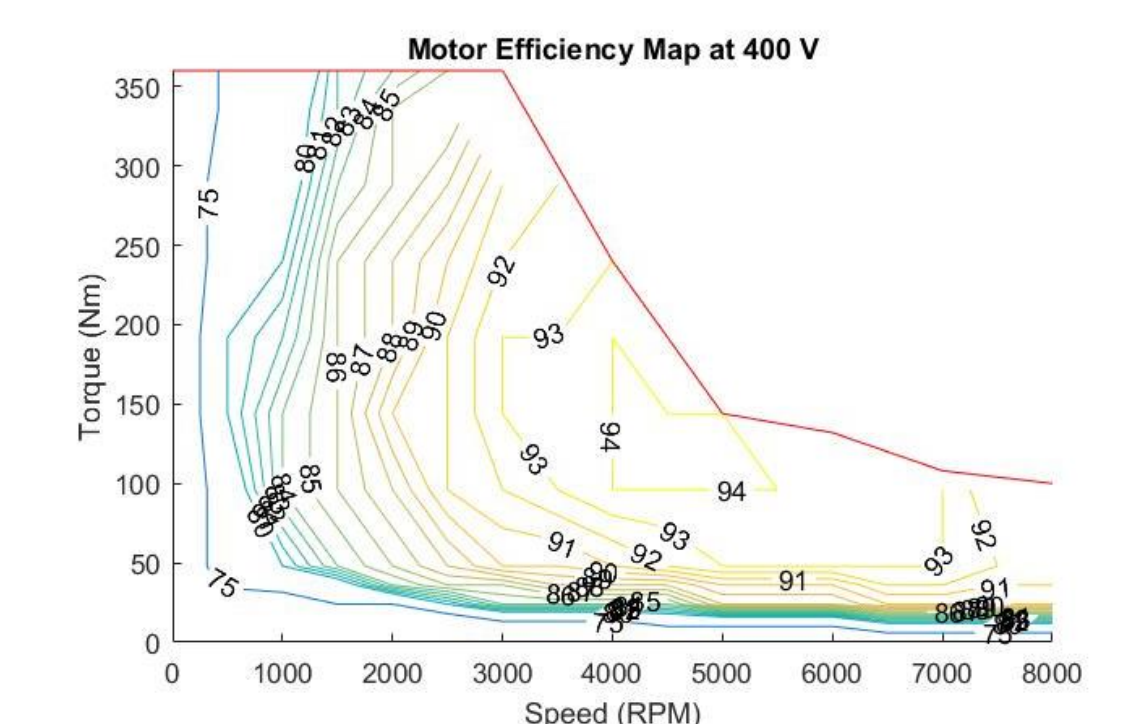

Topology 1 HESS Mass

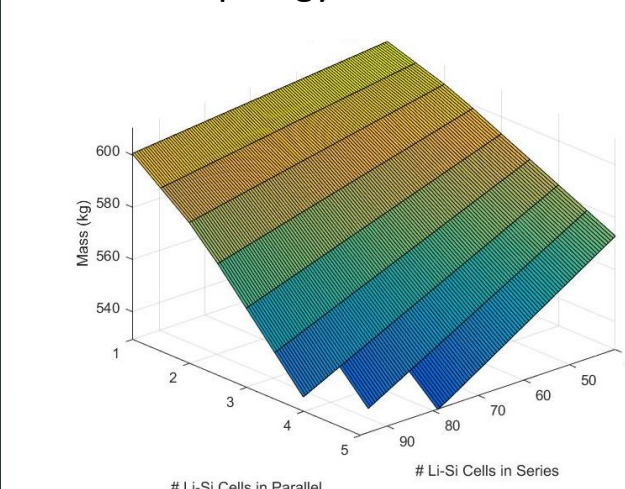

Topology 2 HESS Mass

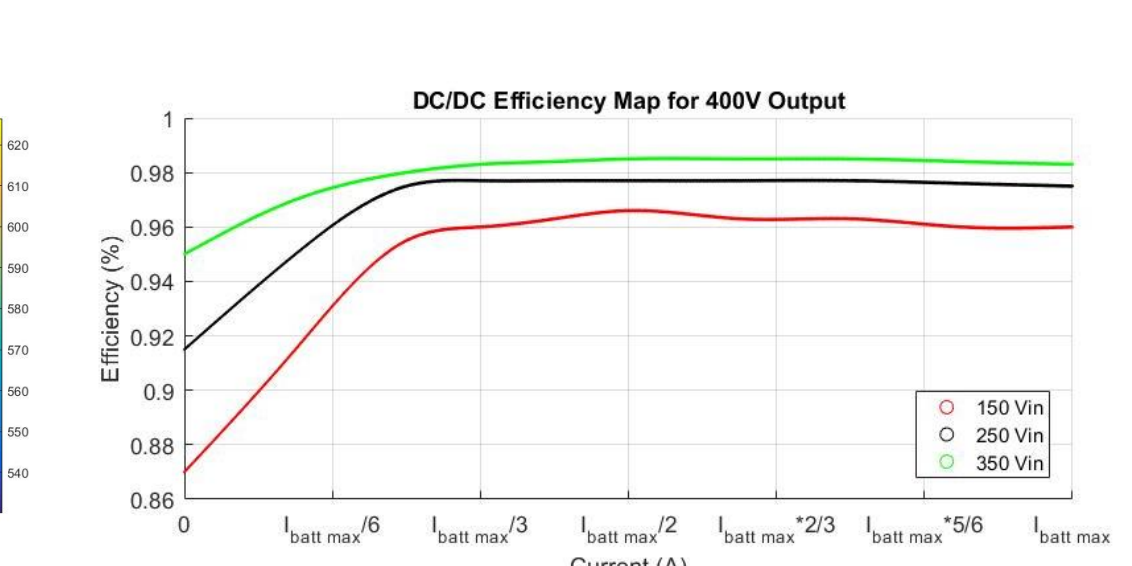
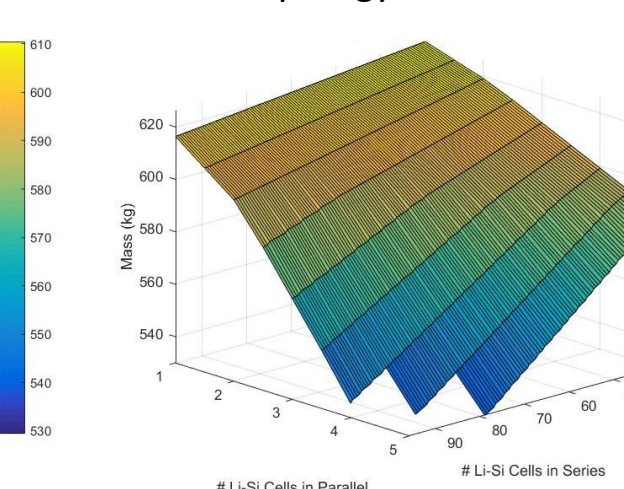

SYSTEM PERFORMANCE

Topology 1 Energy Use

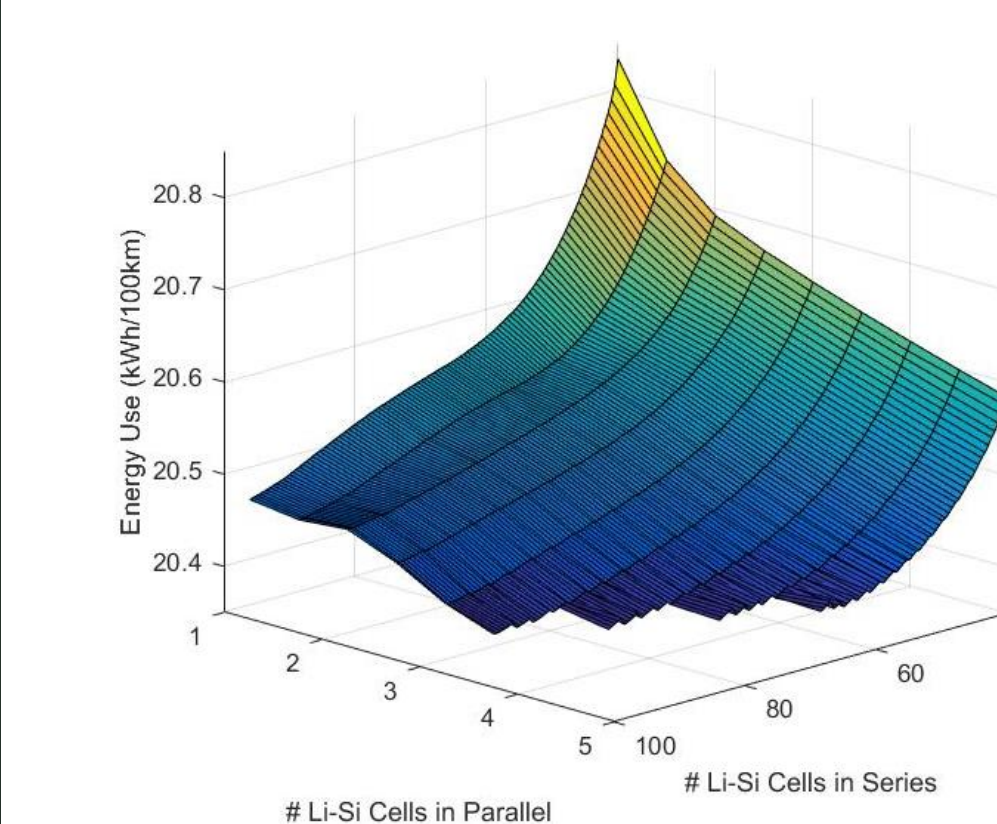

Topology 2 Energy Use

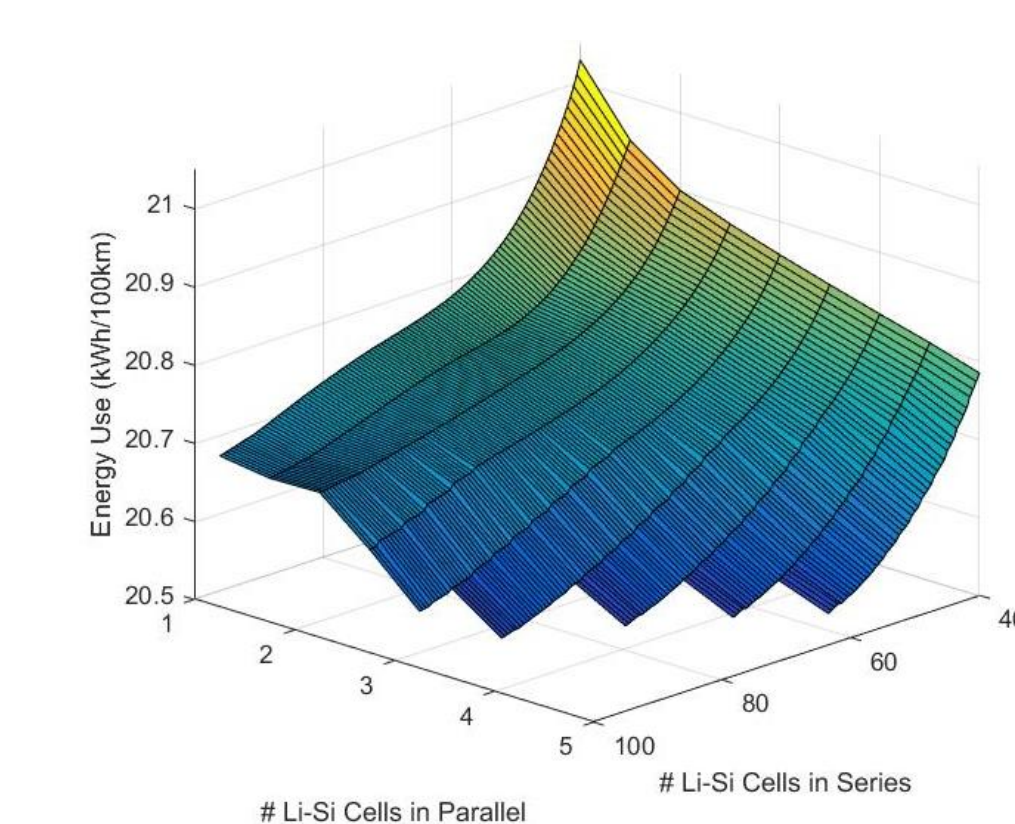

The range was met while achieving a maximum energy consumption rating of 21 kWh/100km. Topology 1 uses less energy due to the direct connection of the battery to the motor/inverter. The increased efficiency from having 4 or more parallel strings is outweighed by the additional cost.

Optimal solutions give combinations of 90 or more series cells with 3 parallel strings.

